

ONYX[®] Swing-arm

User's Guide

Freedom Scientific, Inc.

440483-001 Revision B

PUBLISHED BY
Freedom Scientific
11800 31st Court North
St. Petersburg, Florida 33716-1805
USA
www.FreedomScientific.com

Information in this document is subject to change without notice. No part of this publication may be reproduced or transmitted in any form or by any means electronic or mechanical, for any purpose, without the express written permission of Freedom Scientific.

© 2011 Freedom Scientific, Inc. All Rights Reserved.

ONYX[®], MAGic[®], and MAGic EyeMerge[™] are trademarks of Freedom Scientific, Inc in the United States and other countries.

Federal Communications Commission Notice

This equipment has been tested and found to comply with the limits for a Class B digital device, pursuant to Part 15 of the FCC Rules. These limits are designed to provide reasonable protection against harmful interference in a residential installation. This equipment generates, uses, and can radiate radio frequency energy and, if not installed and used in accordance with the instructions, may cause harmful interference to radio communications. However, there is no guarantee that interference will not occur in a particular installation. If this equipment does cause harmful interference to radio or television reception, which can be determined by turning the equipment off and on, the user is encouraged to try to correct the interference by one or more of the following measures:

- Increase the separation between the equipment and receiver.
- Connect the equipment into an outlet on a circuit different from that to which the receiver is connected.
- Reorient or relocate the receiving antenna.
- Consult the dealer or an experienced radio or television technician for help.

Do Not Make Modifications to Remote Control

Changes or modifications not expressly approved by the party responsible for compliance could void the user's authority to operate the equipment.

Table of Contents

Overview	1
ONYX Swing-arm Components	2
What's in the Box	2
Safety and Maintenance	3
Getting Started	5
Assembling ONYX	5
Camera Assembly.....	5
Video to Television Connections.....	8
Camera to Video Box Connection.....	9
Video Box Power Connection	9
Turning On the ONYX Swing-arm.....	10
Positioning Camera for Long Distance or Close-up Work	11
Basic Operation Using the ONYX Remote Control.....	13
Turning On and Off the ONYX Swing-arm.....	13
Removing the Remote Control Button Cover.....	14
Changing Magnification	15
Adjusting Brightness	15

Changing Viewing Modes	15
Aiming the Camera at a Distant Image	16
Flipping an Image.....	16
Freezing an Image	17
Auto Focus Toggle.....	17
Masking.....	18
Reading Lines	19
Saving Camera Settings	20
ONYX Remote Control Functions.....	21
Power/Function LED (Red)	22
Power (Green)	22
Find (Red)	23
Flip (Light Blue)	23
Video Mode (Blue)	24
Brightness (Yellow)	24
Zoom (Black).....	25
Freeze Frame (Red)	25
Focus Lock (Orange)	26
Reading Lines (Black and White).....	26
Mask (Black and White)	27

Width (White)	27
Up and Down (Black)	27
Pairing a Remote Control with a Camera	28
Service and Support	31
Troubleshooting.....	32

The ONYX[®] Camera makes seeing printed type, pictures, handwriting, and small details easier than ever before.

The ONYX includes the following features:

- Document reading
- Distance reading
- Self viewing
- Auto Focus creates the clearest view without any need to make adjustments.
- Adjust pre-set video modes for high contrast text that is most comfortable for your individual eyesight.
- Increase or decrease brightness
- Masking
- Reading Lines
- Freeze frame
- Find function to easily target distant objects

ONYX Swing-arm Components

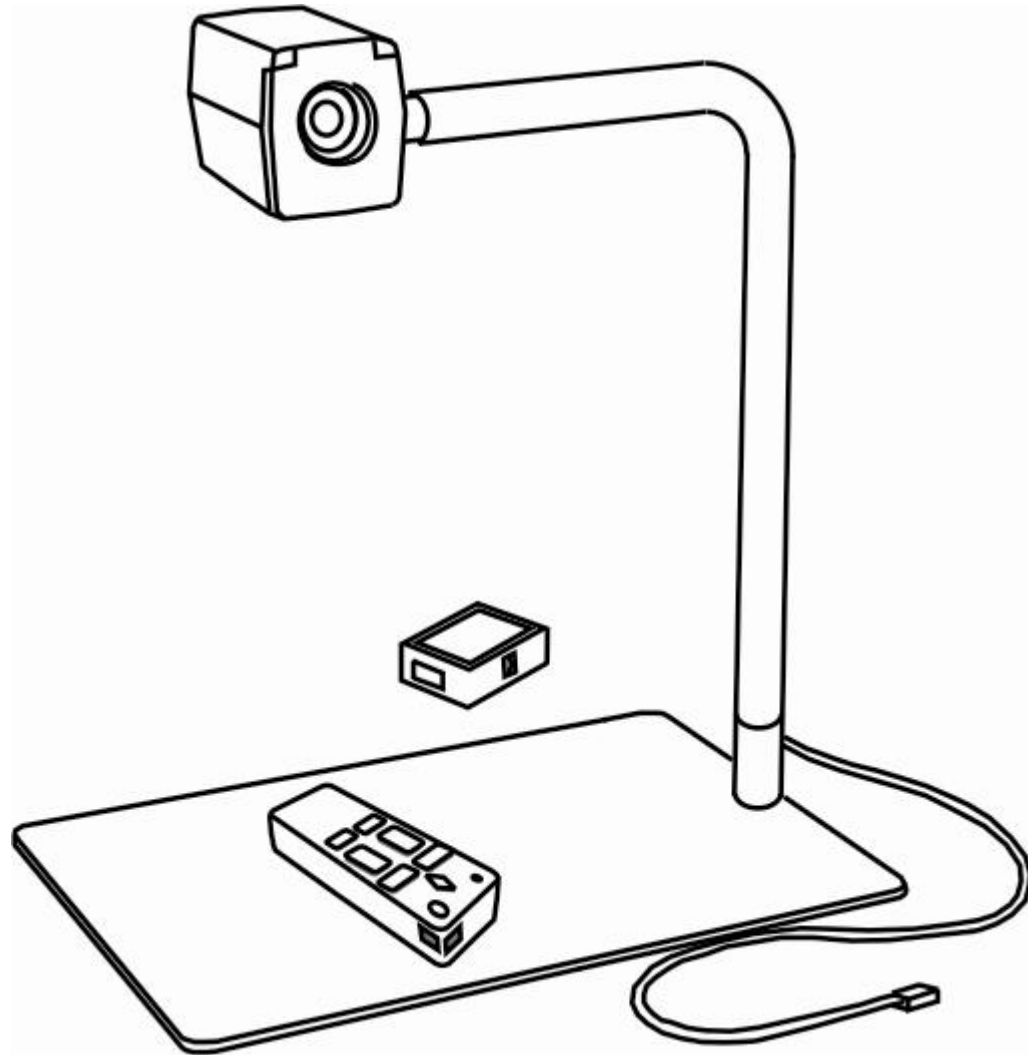

What's in the Box

- ONYX magnifying camera
- Base plate
- Swinging camera arm
- ONYX video interconnect box
- Remote control with two AAA batteries
- Video cable
- Power cable and universal 110-240V AC adapter
- ONYX user's guide

Safety and Maintenance

To keep the unit in good condition and to ensure safe usage, observe the following guidelines:

- Read the instructions in this user's guide before attempting to use the unit.
- Do not attempt to repair the unit or open its case. This product contains no user serviceable parts.
- Do not attempt to modify the remote control. Changes or modifications not expressly approved by the party responsible for compliance could void the user's authority to operate the equipment.
- Keep the unit away from wet areas, rain, and other sources of liquids or high humidity. Do not submerge the unit.
- Always operate the unit in a place where the temperature is between 10° and 40° C (50° and 104° F).
- Always store the unit in a place where the temperature is between -20° and 65° C (-4° and 149° F). Do not store in a parked car, because the temperature often exceeds this range.
- Always use the unit on a stable, level, hard surface such as a desk or table.
- Never force connectors into the unit's ports. All appropriate connectors should fit easily into the ports. If the connector does not fit, turn it around, and try again.

- Use only the power cable that came with your unit. Other adapters may damage the unit.
- When cleaning the unit, use a clean, soft cloth. Do not spray or pour any liquid on the unit or monitor screen.

Assembling ONYX

Before beginning the assembly, place the ONYX components on a sturdy and stable work surface, such as a desk or table. Assembly is straightforward and will be very familiar to you after setting it up for use and breaking it down for travel.

Camera Assembly

1. Place the base plate flat on the table and place the camera arm on to the base plate pin. Make sure to seat it completely down over the pin.
2. Attach the camera to the camera arm connector.

Note: The camera and camera arm connector have a tongue and groove design. Make sure that the top groove on the camera's connector fits snugly over the top of the camera arm connector as shown in the following illustration.

3. Rotate the locking lever down to lock the camera in place.

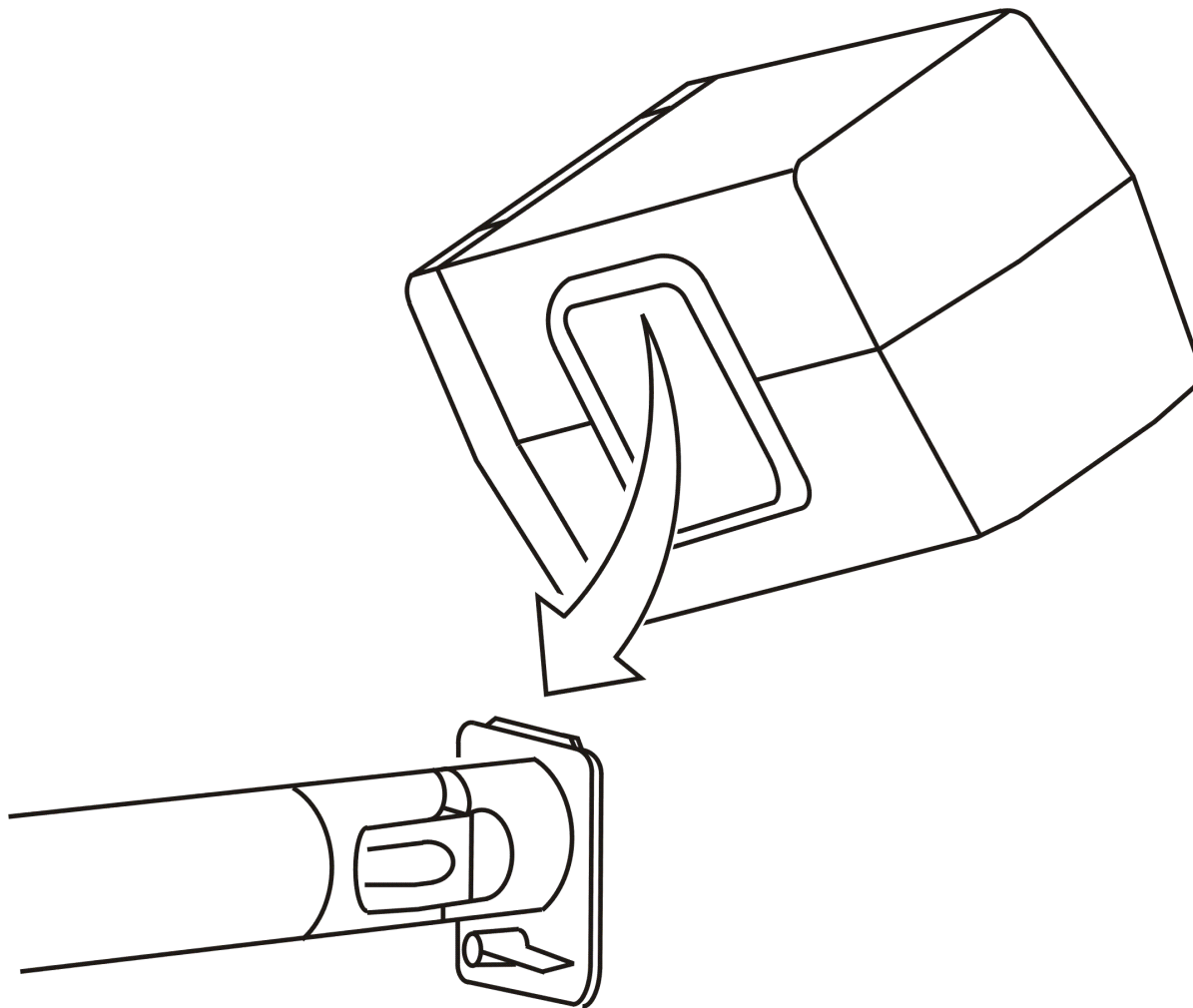

Attaching the ONYX camera to the camera arm connector

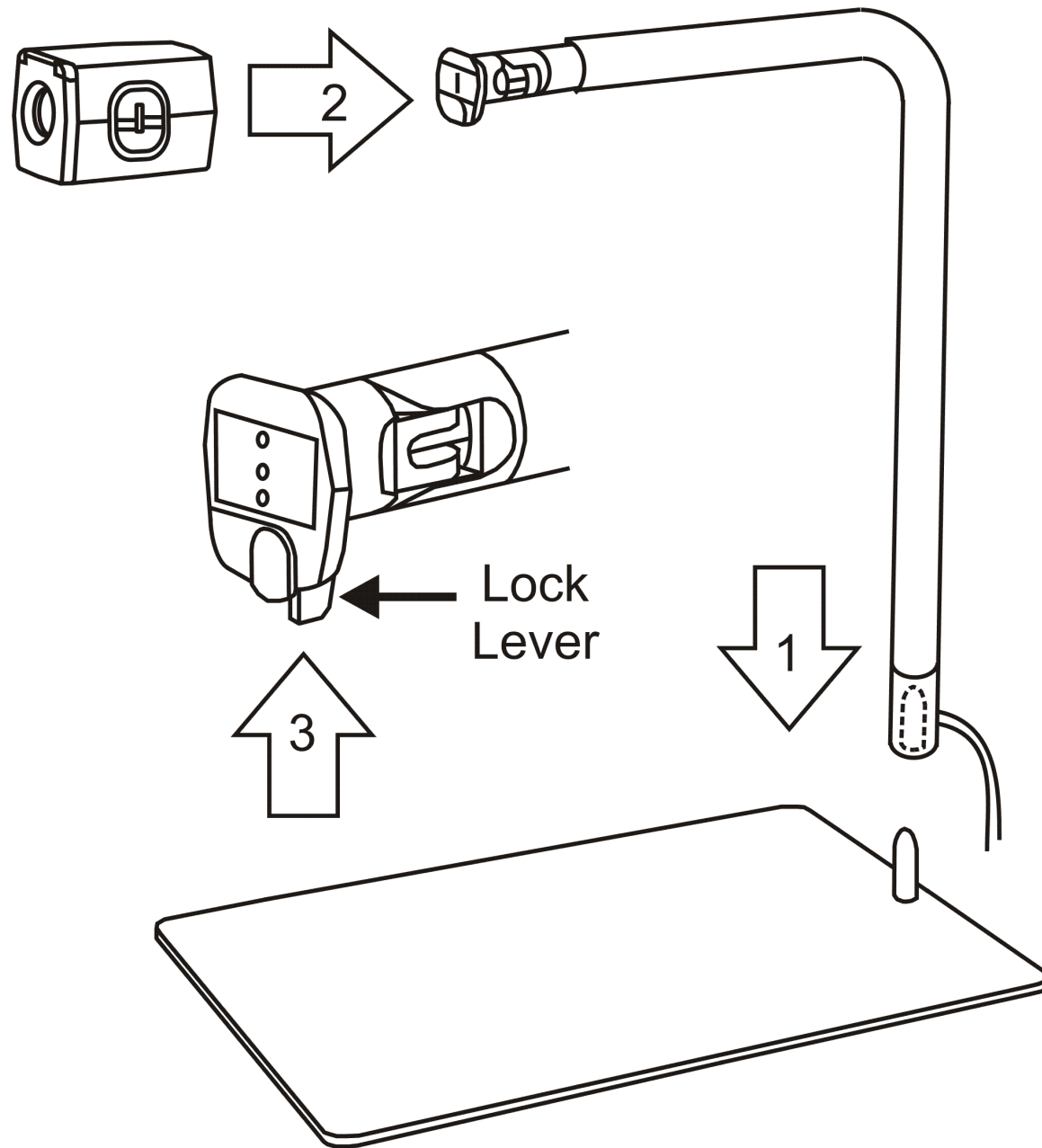

ONYX Swing-arm camera assembly

Video to Television Connections

1. Connect the yellow video jack on the video cable to the yellow video connector on the television.

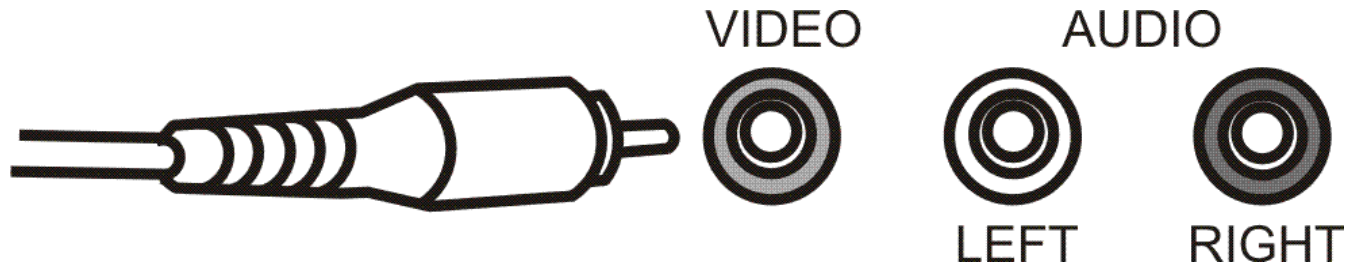

Connecting video cable to video connector on television

2. Connect the other end of the video cable, with the yellow video jack, to the video box.

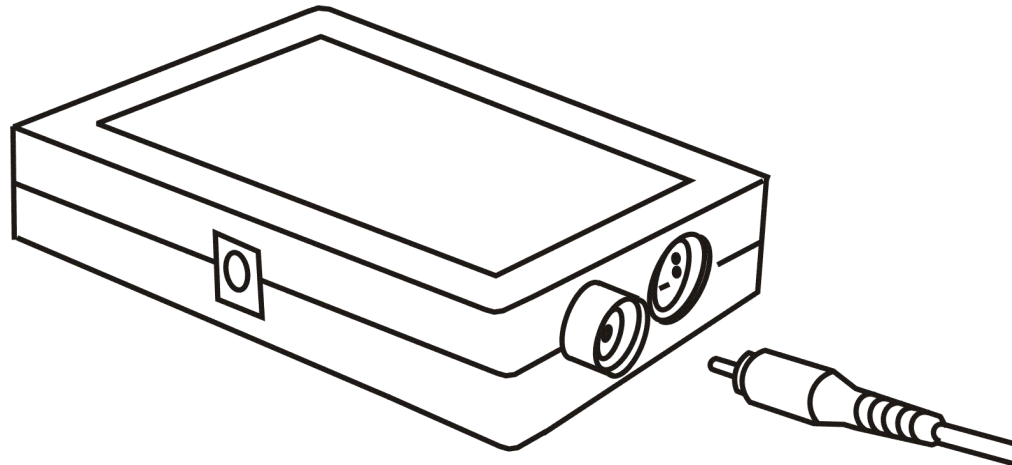

Connecting video cable to video box

3. Turn on the television and change the source to AUX or VIDEO channel.

Camera to Video Box Connection

1. Plug the camera's modular RJ45 connector into the RJ45 connector on the video box.

A click sound is made when the modular connector snaps into place.

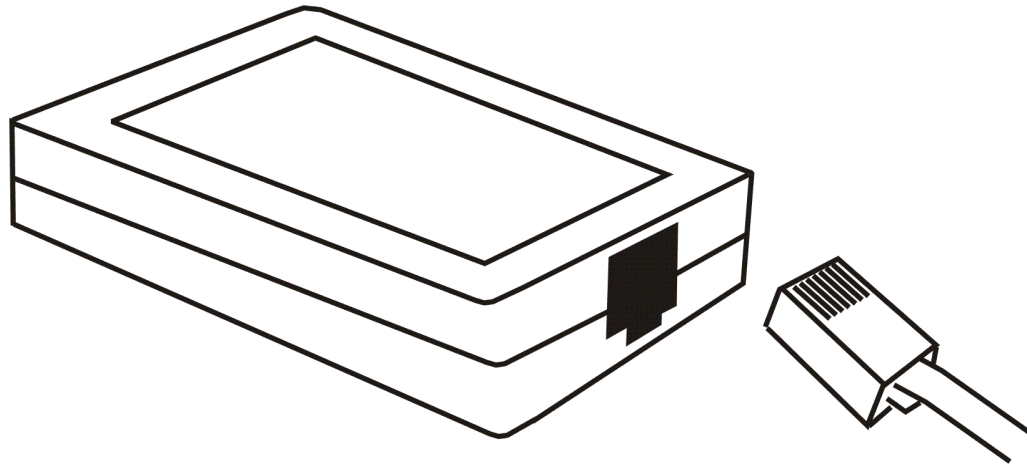

Connecting RJ45 cable from the camera to the video box

Video Box Power Connection

1. Plug the power connector for the video box into the video box.
2. Plug the power adapter into the wall outlet.

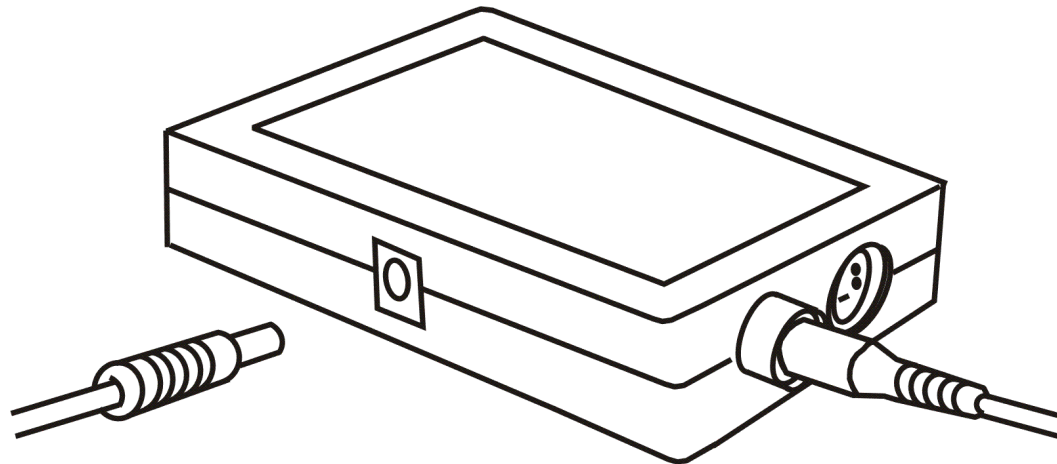

Connecting power cable to video box

Turning On the ONYX Swing-arm

1. Insert two AAA batteries into the remote control.
2. Press the green **POWER** button , located in the upper right corner of the remote control. There is no need to aim the remote control at the camera. When the camera is on, a red LED on the bottom of the camera is lit.
3. If an image does not appear on the television, verify that the television is turned on and that the channel selection is set to AUX or VIDEO.

Positioning Camera for Long Distance or Close-up Work

For long distance reading, keep the camera lens up.

For close-up reading or self viewing, keep the camera lens down.

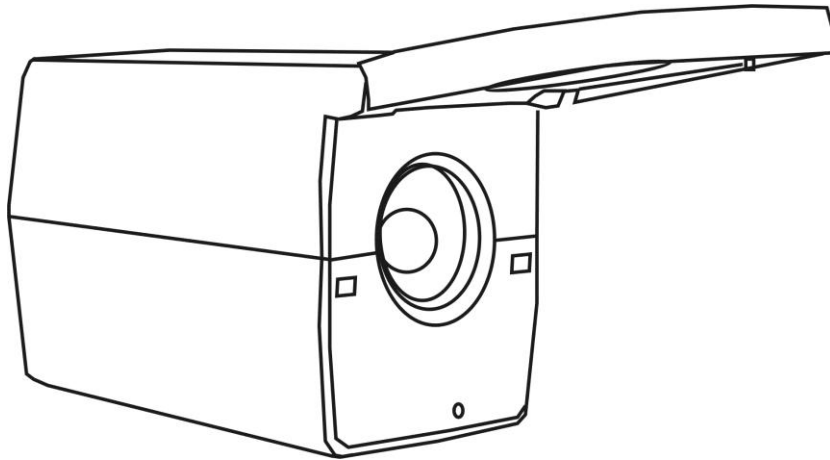

Distance reading configuration

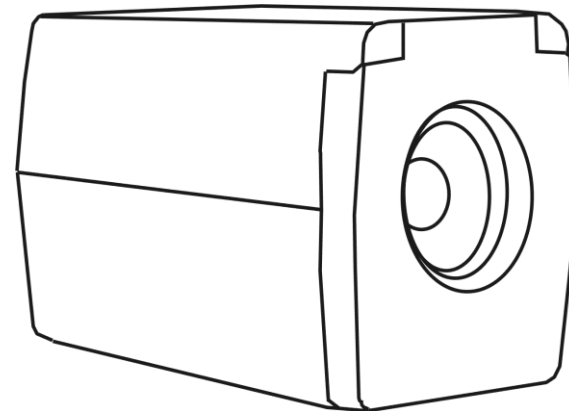

Desktop and self-view configuration

There are four primary camera positions:

- Horizontal with lens up – for looking at distant objects
- Horizontal with lens down – for looking at nearby objects
- Vertical and facing down – for when the camera is rotated to look down at an object on the base plate or desktop
- Horizontal and upside down with lens down – for when the camera is rotated and pointed at yourself for self viewing



When the camera is placed into each of these different positions, it recalls the brightness, magnification, viewing mode, mask, Reading Lines, and other essential settings that you created for that specific position. This allows you to make a separate camera configuration for distance viewing, in which the magnification and brightness are adapted for that situation, while also having a separate configuration for desktop viewing, one that takes magnification, viewing mode, and brightness into account when reading a book.

Important:

Any changes made to the camera while it is in a given position are automatically saved and used the next time you move the camera to that position. To permanently save these settings, you must power the ONYX off using the green POWER button on the remote control.

Basic Operation Using the ONYX Remote Control

Turning On and Off the ONYX Swing-arm

1. Connect all cables as previously described in the Getting Started section.
2. Turn on the television and select the appropriate channel.
3. Press the green **POWER** button  on the remote control. Its red LED flashes, and the red LED on the bottom of the camera turns on.
4. Press the green **POWER** button  again to turn off the ONYX.

Removing the Remote Control Button Cover

To remove the cover, do the following:

- While holding the remote control in one hand, use your other thumb to slide the cover down and off to expose the **MASK** and **READING LINES** buttons.

Additional Features:

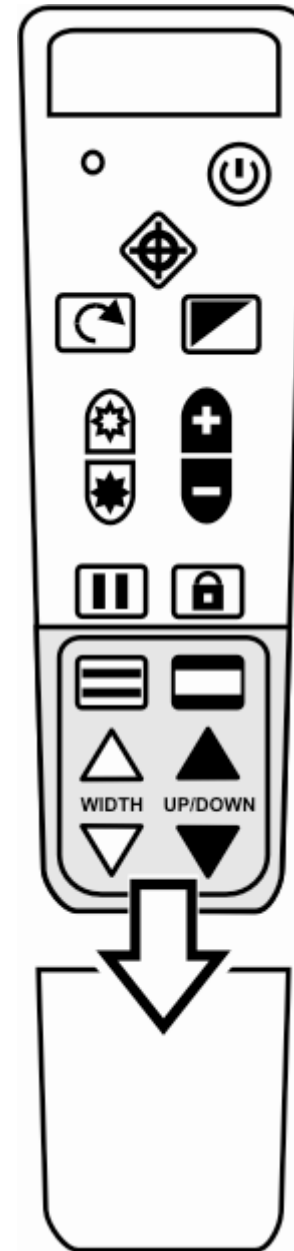

Masking and Reading Lines are functions to help you focus and maintain your place while reading. To access these additional features, you must remove the button cover located at the bottom of the remote control below the other buttons.

For information about these functions, see *Masking* on page 18 and *Reading Lines* on page 19.





Removing button cover

Changing Magnification

- Press the black **PLUS** button , which is located in the center right of the remote control, to zoom-in and enlarge the object that appears on the screen.
- Press the black **MINUS** button , also located in the center right of the remote control, to zoom away from the object on the screen.

Adjusting Brightness

- To make the image lighter, press the top yellow **BRIGHTNESS** button , which is located in the center left of the remote control.
- To make the image darker, press the bottom yellow **BRIGHTNESS** button , which is located in the center left of the remote control.



Changing Viewing Modes

Press the blue **VIDEO MODE** button , located in the upper right of the remote control, to cycle through different viewing modes:

- Normal (full color)
- Inverted Color
- Black on White (enhanced positive)
- White on Black (enhanced negative)

Aiming the Camera at a Distant Image

If you are currently focused on an object, but you want to move the camera to another object, use the **FIND** and **ZOOM** buttons to help you aim the camera, locate the center of the new object, and return to your initial magnification level.

1. Press the red **FIND** button , which is located in the upper center section of the remote control. Crosshairs appear on the screen indicating the center of the image on the screen.
2. Press the black **MINUS** button  to zoom out.
3. Move the camera and center the crosshairs on the new object you want to view.
4. Press the red **FIND** button  again. The camera zooms in to its previous magnification level and the crosshairs turn off.

Flipping an Image

With the ONYX camera, you can change the screen orientation so that the image is flipped and mirrored both horizontally and vertically. (Note that the camera is configured so that it will flip to a mirror image when rotated into the self-viewing position.)

This function is useful when the object you are viewing is upside down. For example, if you receive a heavy package, it may be easier to flip the image around instead of turning over the package.

- Press the light blue **FLIP** button , located in the upper left of the remote control, four times to cycle through the four different picture orientations.



Note: The camera will remember this setting the next time you rotate it back to this position.

Freezing an Image

- Press the red **FREEZE FRAME** button  to freeze the current image that appears on the screen. The Menu text FREEZE appears in the lower left corner of the screen. This is useful when viewing distant images such as text on a blackboard.
- To turn off Freeze Frame and return to the camera's live view, press the button again.

Auto Focus Toggle







By default, the camera will adjust its focus to the nearest object in view. However, when working or writing directly under the camera, you may want to turn this feature off.

1. Press the orange **FOCUS LOCK** button , which is located on the lower left side of the remote control, to turn Auto Focus off. The Menu text LOCK appears in the lower left corner of the screen. The camera's focus setting will not change meaning that an object moved closer to or farther away from the camera lens will be out of focus.
2. Press the orange **FOCUS LOCK** button  again to return to the camera's standard Auto Focus live view.

Masking

Masking blocks the upper and lower halves of the screen, making it easier for you to focus on a specific area of the screen and reducing glare.





Note: To access the **MASK** controls, remove the button cover located at the bottom of the remote control. See *Removing the Remote Control Button Cover* on page 14 for more information.

1. To turn on masking, press the black and white **MASK** button , which is located on the lower right side of the remote control.
2. To adjust the size of the mask, do one of the following:
 - Press the white **UP ARROW** button , labeled Width, to narrow the mask.
 - Press the white **DOWN ARROW** button  to widen the mask.
3. To adjust the position of the mask on the screen, do one of the following:
 - Press the black **UP ARROW** button  to move the mask up the screen.
 - Press the black **DOWN ARROW**  to move the mask down the screen.
4. To toggle the mask on and off, press the black and white **MASK** button  again.

Reading Lines

Reading Lines are used to help you maintain your place while reading text. To use Reading Lines, do the following:

Note: To access the **READING LINES** controls, remove the button cover located at the bottom of the remote control. See *Removing the Remote Control Button Cover* on page 14 for more information.

1. Press the black and white **READING LINES** button , which is located on the lower left side of the remote control, to display two horizontal lines.
2. To adjust the distance between Reading Lines, do one of the following:
 - Press the white **UP ARROW** button , labeled Width, to move the bottom reading line up the screen, thus decreasing the distance between lines.
 - Press the white **DOWN ARROW** button  to move the bottom reading line down the screen and increase the distance between lines.
3. To adjust the position of the Reading Lines, do one of the following:
 - Press the black **UP ARROW** button , located in the lower right corner of the remote control, to move the mask up the screen.
 - Press the black **DOWN ARROW**  to move the mask down the screen.

4. To toggle Reading Lines on and off, press the black and white **READING LINES** button  again.

Saving Camera Settings

- To save camera settings, turn ONYX off using the green **POWER** button , located in the upper right corner of the remote control.

Note: Camera settings are unique to the camera's position. For example, if Reading Lines are used while reading a document in the desktop position, they may not appear when the camera is rotated and aimed at a blackboard or yourself. Also, if you unplug ONYX from the wall outlet without turning it off first, any recently configured camera settings are discarded. To save camera settings, always use the green **POWER** button to turn off the ONYX. For more information about camera settings, see *Positioning Camera for Long Distance or Close-up Work* on page 11.

ONYX Remote Control Functions



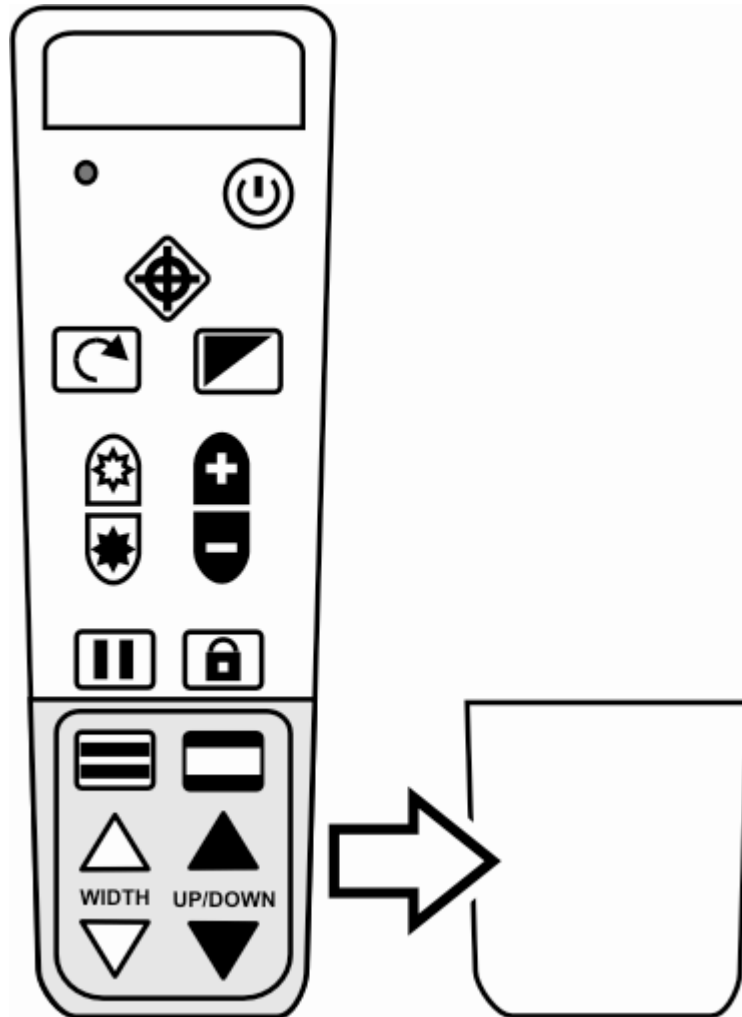

This section describes each button on the remote control.









ONYX remote control



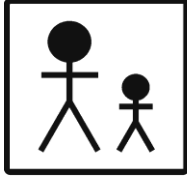
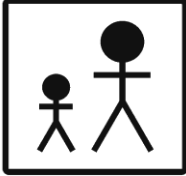
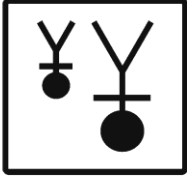
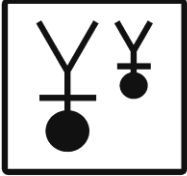
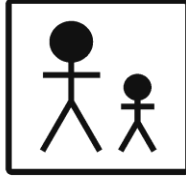

This device complies with Part 15 of the FCC Rules. Operation is subject to the following two conditions: (1) this device may not cause harmful interference, and (2) this device must accept any interference received, including interference that may cause undesired operation.



Note: Slide the button cover down and off to access the **MASK** and **READING LINES** buttons. For more information, see *Removing the Remote Control Button Cover* on page 14.

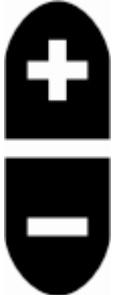

Button/LED	Description and Function
	<p>Power/Function LED (Red)</p> <p>This LED flashes red each time you press a button on the remote control. It is located in the upper left corner of the remote control.</p>
	<p>Power (Green)</p> <p>Press the POWER button  to turn the power on for the video source and camera. To turn the power off, press and hold the POWER button . The red LED on the camera indicates that it is on.</p> <p>The POWER button is located in the upper right corner of the remote control.</p>

Button/LED	Description and Function
	<p>Find (Red)</p> <p>Press the FIND button to locate the center of the object that is currently in view and focus. This is indicated by the crosshairs that appear on screen. You can then zoom out, using the black MINUS button , and move the camera to place the crosshairs on a different object. Press the FIND button again and the camera zooms in to the previous magnification level. The crosshairs then disappear.</p> <p>This button is located in the upper center section of the remote control.</p>
	<p>Flip (Light Blue)</p> <p>Pressing the FLIP button four times cycles the camera through four different picture orientations.</p> <div style="display: flex; justify-content: space-around; align-items: flex-end;"> <div style="text-align: center;">  <p>Normal</p> </div> <div style="text-align: center;">  <p>Press 1x</p> </div> <div style="text-align: center;">  <p>Press 2x</p> </div> <div style="text-align: center;">  <p>Press 3x</p> </div> <div style="text-align: center;">  <p>Press 4x</p> </div> </div> <p>This button is located in the upper left side of the remote control.</p>

Button/LED	Description and Function
	<p>Video Mode (Blue)</p> <p>Press the VIDEO MODE button, which is located in the upper right side of the remote control, to cycle through the following color modes:</p> <ul style="list-style-type: none"> ■ Normal color ■ Reverse color ■ Enhanced Positive (black on white) ■ Enhanced Negative (white on black)
	<p>Brightness (Yellow)</p> <p>Press the top BRIGHTNESS button  to increase the brightness level.</p> <p>Press the bottom BRIGHTNESS button  to decrease the brightness level.</p> <p>These buttons are located in the center of the remote control.</p>

Button/LED	Description and Function
	<p>Zoom (Black)</p> <p>Press the PLUS button  to zoom-in and enlarge the object that appears on the screen.</p> <p>Press the MINUS button  to zoom away from the object on the screen.</p> <p>These buttons are located in the center of the remote control.</p>
	<p>Freeze Frame (Red)</p> <p>Press the FREEZE FRAME button  once to freeze the current image that appears on the screen. The on screen message FREEZE appears on the screen.</p> <p>Press it again to turn off Freeze Frame mode and return to the live camera view. It is located on the lower left side of the remote control.</p>

Button/LED	Description and Function
	<p>Focus Lock (Orange)</p> <p>Auto Focus mode, also known as Focus Lock, allows the camera to automatically focus on the closest object in view. Auto Focus is on by default.</p> <p>Press the FOCUS LOCK button  to turn off Auto Focus. When Auto Focus is off, as indicated by the on-screen message, LOCK, the camera does not adjust its focus. Turning Auto Focus off makes it easier to write or work with an object, because the camera will not automatically focus on your hand. During normal operation, it is recommended that you leave Auto Focus on.</p> <p>Press the button again to restore Auto Focus mode. It is located on the lower right side of the remote control.</p>
	<p>Reading Lines (Black and White)</p> <p>Press the READING LINES button to display two horizontal lines on the screen. Use these lines to help you maintain your place while reading text. You can then use the WIDTH and UP/DOWN buttons to adjust the distance between lines and position on the screen. Remove the button cover on the front of the remote control to access these buttons.</p>

Button/LED	Description and Function
	<p>Mask (Black and White)</p> <p>Press the MASK button to cover the upper and lower parts of the screen so that you can concentrate on specific items or lines of text that appear on the screen. You can use the WIDTH and UP/DOWN buttons to adjust the visible area and position on the screen. Remove the button cover on the front of the remote control to access these buttons.</p>
	<p>Width (White)</p> <p>Use these buttons to move the bottom reading line or mask on the screen. This action closes and opens the distance between reading lines or the mask. Remove the button cover on the front of the remote control to access these buttons.</p>
	<p>Up and Down (Black)</p> <p>Use these buttons to move the reading lines or mask up and down the screen. Remove the button cover on the front of the remote control to access these buttons.</p>

Pairing a Remote Control with a Camera

An ONYX camera always corresponds with a specific ONYX remote control. You cannot take a remote control from another camera and automatically use it with your camera. Both the camera and remote control must match. To match or pair another remote control with your camera, do the following:

Note: An unfolded paper clip is required for this procedure. Because the following tasks must be performed within a specified time limit, review and make sure that you understand this procedure before attempting to pair a camera and remote control.

1. Make sure that your ONYX camera is connected to the RJ45 connector on the video box, and that power is connected to the unit.
2. Use an unfolded paper clip to press and release the recessed **PAIRING** button on the bottom of the ONYX camera. The button is located between the serial number label and the camera lens. See the next illustration.

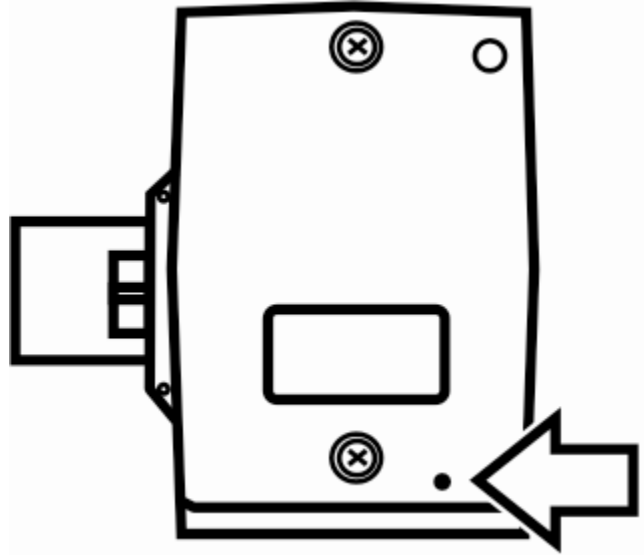

Camera PAIRING button

Note: Step 3 must be done within 10 seconds after pressing the camera's **PAIRING** button.

3. Open the battery cover on the back of the ONYX remote control. Insert and press the unfolded paper clip into the recessed **PAIRING** button (the hole above and to the right of the batteries). See the next illustration.

The remote control's LED will flash approximately 10 times.

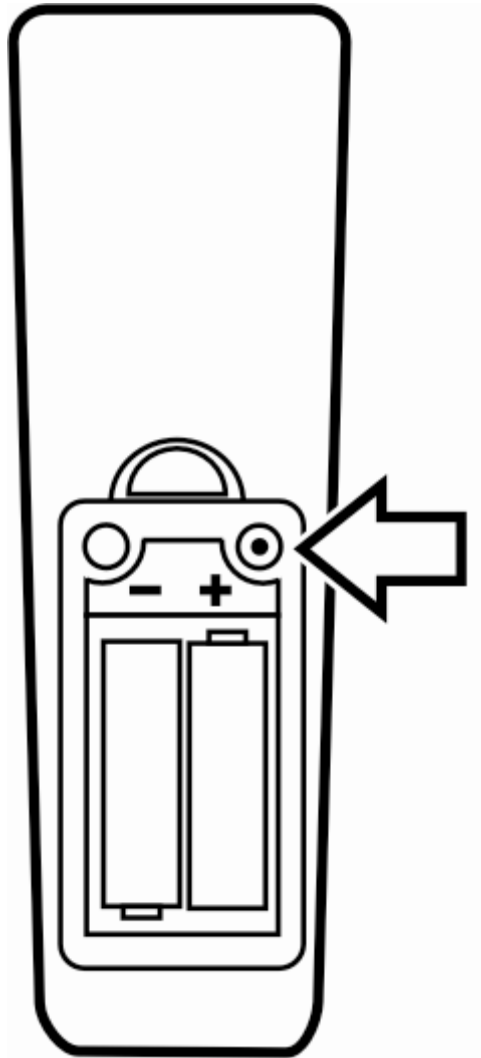

Remote control PAIRING button

4. Press the remote control's green **POWER** button  and verify that the camera turns on. The red LED on the bottom of the camera will turn on. This indicates that the camera and remote control are correctly paired. Replace the battery cover on the remote control.

Service and Support

You can contact Freedom Scientific Technical Support to receive technical assistance with ONYX. Before contacting Technical Support, it is recommended that you refer to *Troubleshooting* on page 32 to try to resolve your problem quickly.



If you cannot resolve your issue, you can visit www.FreedomScientific.com. Choose the **Support** link to search the Knowledge Base. The Knowledge Base contains articles that address many common questions and technical issues concerning Freedom Scientific products.



Note: This device has no user-serviceable components. Any unauthorized attempt to service or replace internal components will void the product warranty.





To contact Freedom Scientific Technical Support by telephone, customers in the United States can call (727) 803-8600, Monday through Friday, from 8:30 A.M. to 7:00 P.M. (Eastern Time). Alternatively, you can receive support by e-mail. Send your questions and problems to Support@FreedomScientific.com.



When you call, have your documentation ready and be prepared to provide the following information:

- Product name
- What you were doing when the problem occurred
- How you tried to solve the problem

Problem	Solution
<p>The screen is blank.</p>	<p>Ensure that the television is powered on and that the Power LED for the camera is on. The red Power LED is located on the bottom of the camera.</p> <p>Check that all cables are correctly connected.</p> <p>Reduce the magnification level using the black MINUS button .</p> <p>Try adjusting brightness using the yellow BRIGHTNESS buttons  or .</p> <p>Press the blue VIDEO MODE button to switch to a different video mode.</p>

Problem	Solution
<p>The unit does not turn on.</p>	<p>Ensure that the camera and television player are both plugged in.</p> <p>Ensure that the wall outlets have power and are not malfunctioning. If the outlets are connected to a wall switch, make sure that the switch is on.</p> <p>Ensure that the remote control is working. The red LED in the upper left corner of the remote control flashes when a button is pushed. If this does not happen, replace the two AAA batteries.</p> <p>Make sure that you use the remote control that is paired with your camera.</p>
<p>The image on the screen is too bright, or there is a glare from the screen that makes it difficult to see.</p>	<p>Use the yellow BRIGHTNESS buttons  or  to reduce the brightness.</p> <p>Press the blue VIDEO MODE button  to switch to a different video mode.</p>

Problem	Solution
<p>The image on the screen is too dark.</p>	<p>Use the yellow BRIGHTNESS buttons  or  to increase the brightness.</p> <p>Press the blue VIDEO MODE button  to switch to a different video mode.</p>
<p>The image on the screen is blurry or unfocused.</p>	<p>Lift the camera lens and let the camera try to regain focus.</p> <p>Ensure that Auto Focus is on. You can press the orange FOCUS LOCK button  to turn Auto Focus on or off.</p> <p>Move the object to within 15 inches of the camera with the lens down or at least 30 inches away from the camera with the lens up.</p> <p>Make sure that the lens is clean.</p> <p>Check that there are no objects in the foreground. The camera might be trying to focus on that object.</p>

Problem	Solution
The image is upside down.	Use the light blue FLIP button  to invert the image.
There are smudges or blemishes on the screen.	Clean the screen using a damp, soft, lint-free cloth.
Text is too small to read.	Use the black PLUS button  to increase the magnification level.
Text is too large.	Use the black MINUS button  to decrease the magnification level.
When I move the camera to a new position, I lose the previous position's settings.	This is normal operation since camera settings are saved and stored per position. For example, if you have Reading Lines turned on for distant viewing, and then change to desktop viewing or self viewing, the Reading Lines will not appear unless you set them for those camera positions.

Problem	Solution
<p>ONYX is connected to a television, but no magnified image appears on the television screen.</p>	<p>Ensure that the television is plugged into the wall outlet.</p> <p>Ensure that the television is on and set to AUX or VIDEO channel.</p> <p>Ensure that the television cable is securely connected to the ONYX video box.</p> <p>Ensure that the television connector cable is securely connected to the appropriate video input jack on the television.</p>
<p>Nothing happens while pressing buttons on the remote control.</p>	<p>Your camera and remote control are matched through firmware. If you use a remote control that is paired with another camera, refer to <i>Pairing a Remote Control with a Camera</i> on page 28 for procedures describing how to match the two devices.</p>